

Arnold Bernhard

**Geometrische Bilder  
für den Menschen und seine  
nachtodliche Verwandlung**

Bildheft

Paracelsus-Zweig Schriftenreihe Nr. 2  
Basel

Paracelsus-Zweig Schriftenreihe Nr. 2

Herausgeber Anthroposophische Gesellschaft,  
Paracelsus-Zweig Basel  
Redaktion Rudolf Bind

Arnold Bernhard

**Geometrische Bilder**  
**für die Dreigliederung des Menschen**  
**und für die nachtodliche Verwandlung**  
**der Kräftestruktur der Röhrenkno-**  
**chen in diejenige der Kopfknochen**

Bildheft

# Inhalt

Geometrische Bilder für die Dreigliederung des Menschen	7
Geometrische Bilder für die nachtodliche Verwandlung der Kräftestruktur der Röhrenknochen in diejenige der Kopfknochen	18

1. Auflage  
© 1998 Arnold Bernhard  
Herausgeber Anthroposophische Gesellschaft, Paracelsus-Zweig Basel  
Redaktion Rudolf Bind  
Herstellung Kooperative Dürnau

# Geometrische Bilder für die Dreigliederung des Menschen

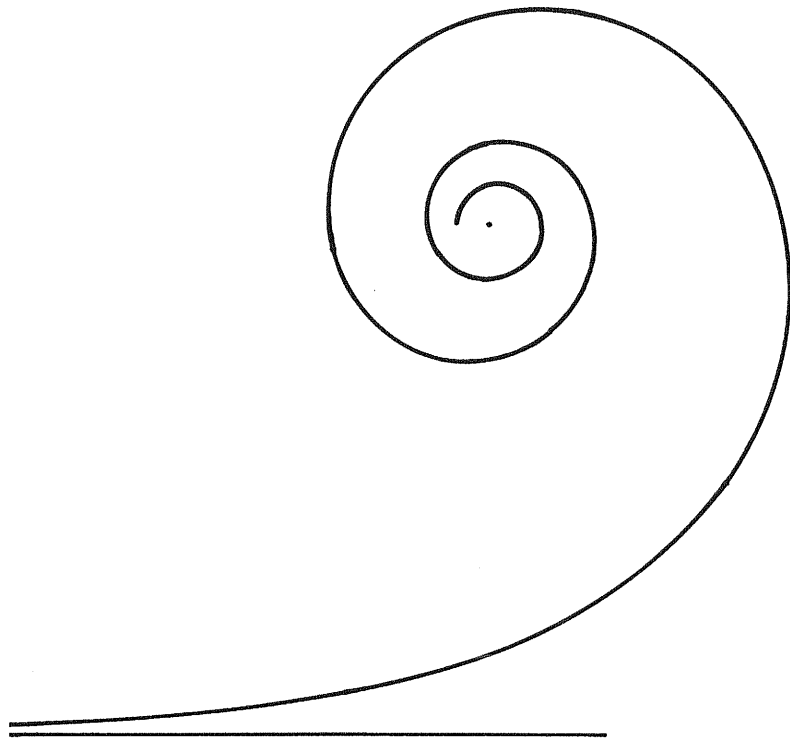

Figur 1

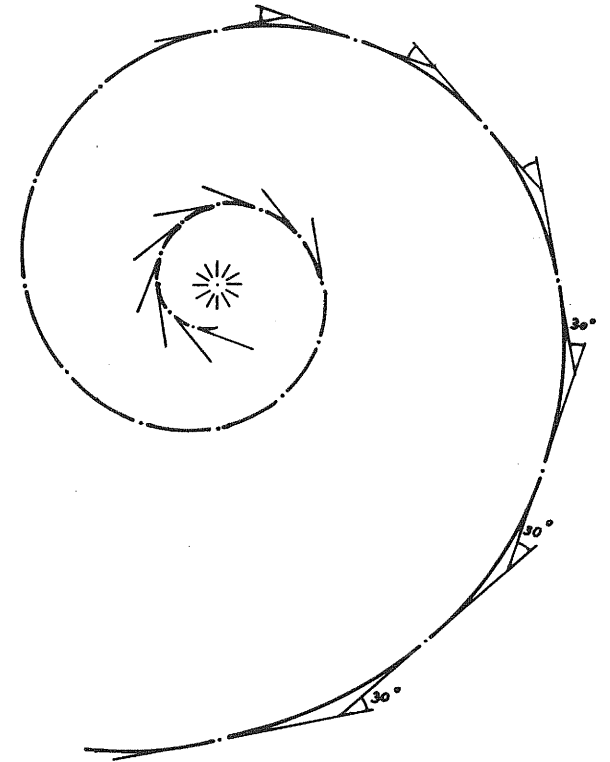

Figur 2

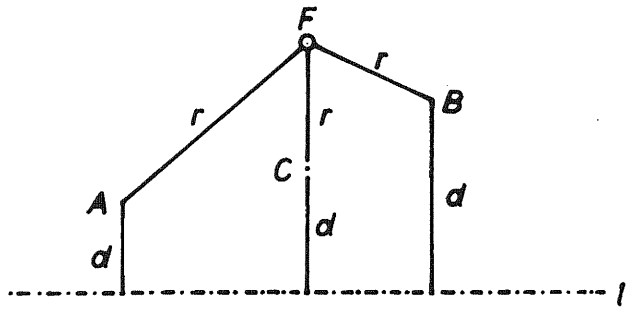

Figur 3

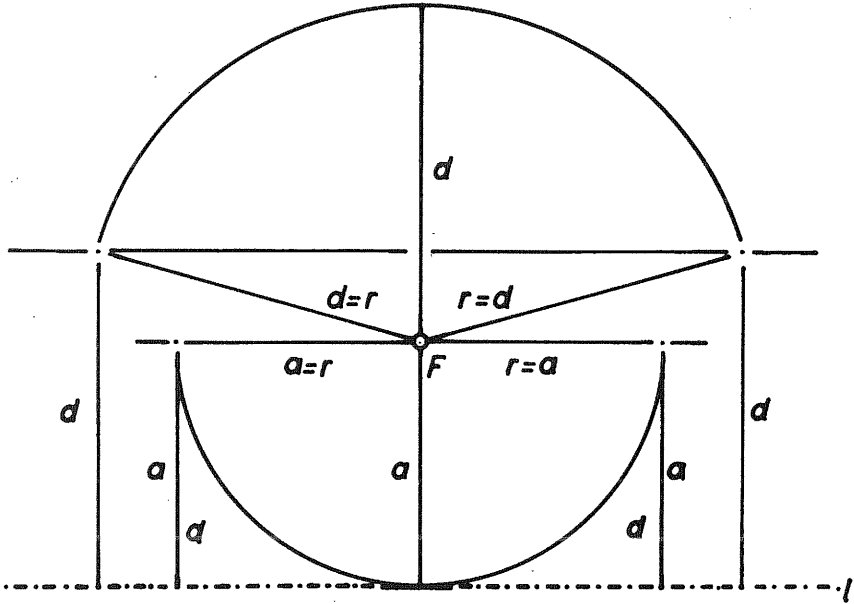

Figur 4

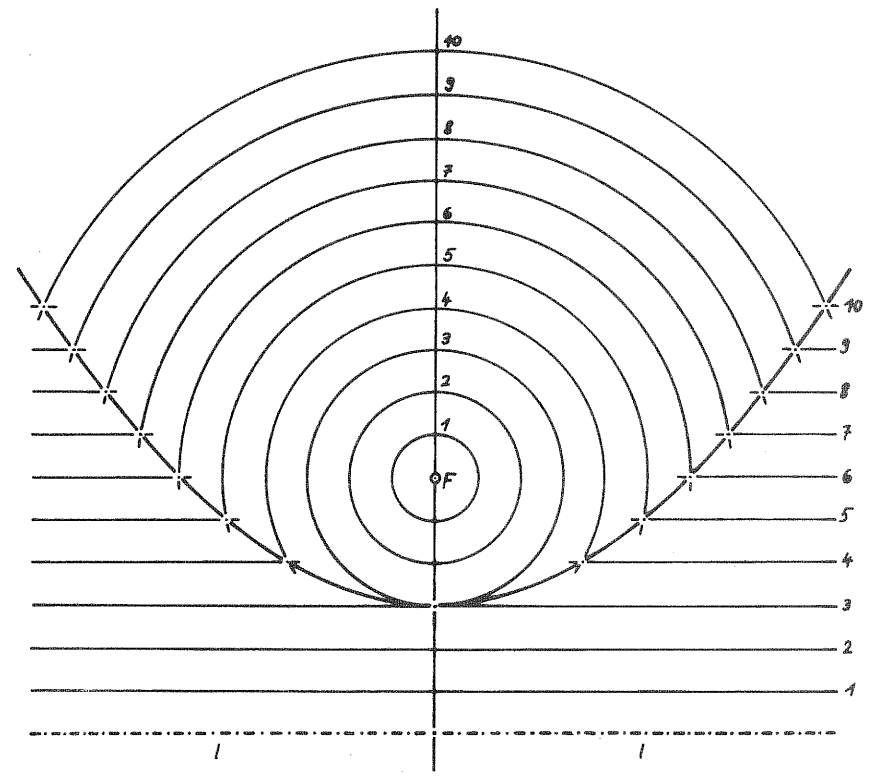

Figur 5

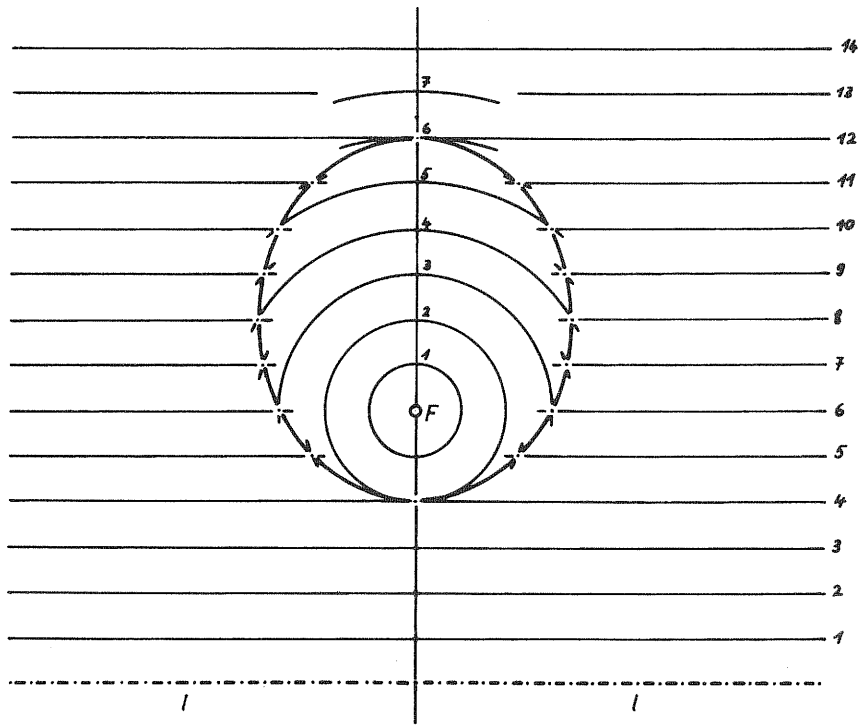

Figur 6

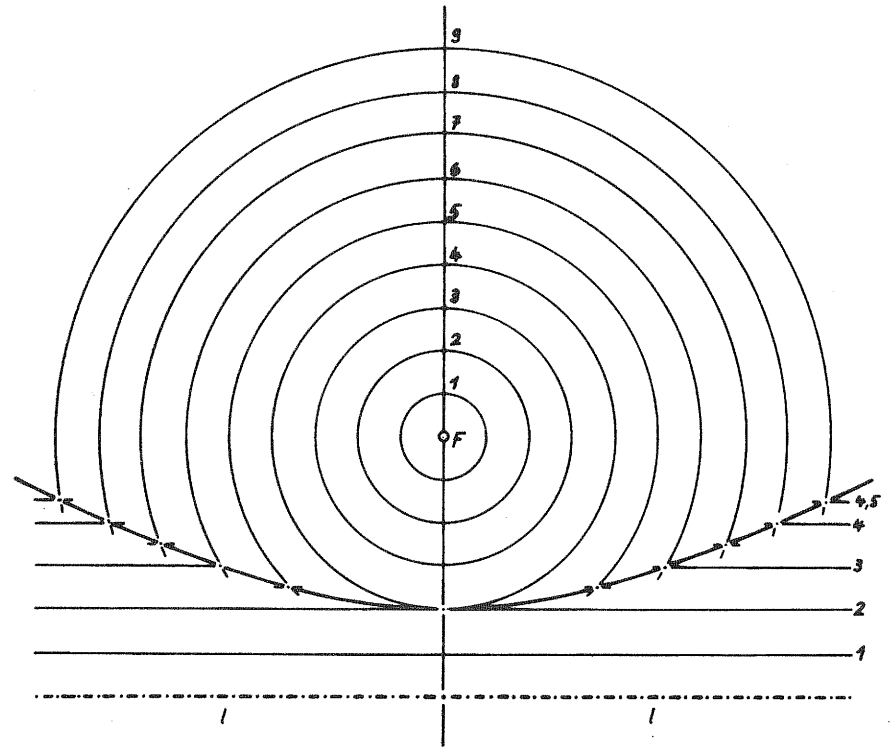

Figur 7

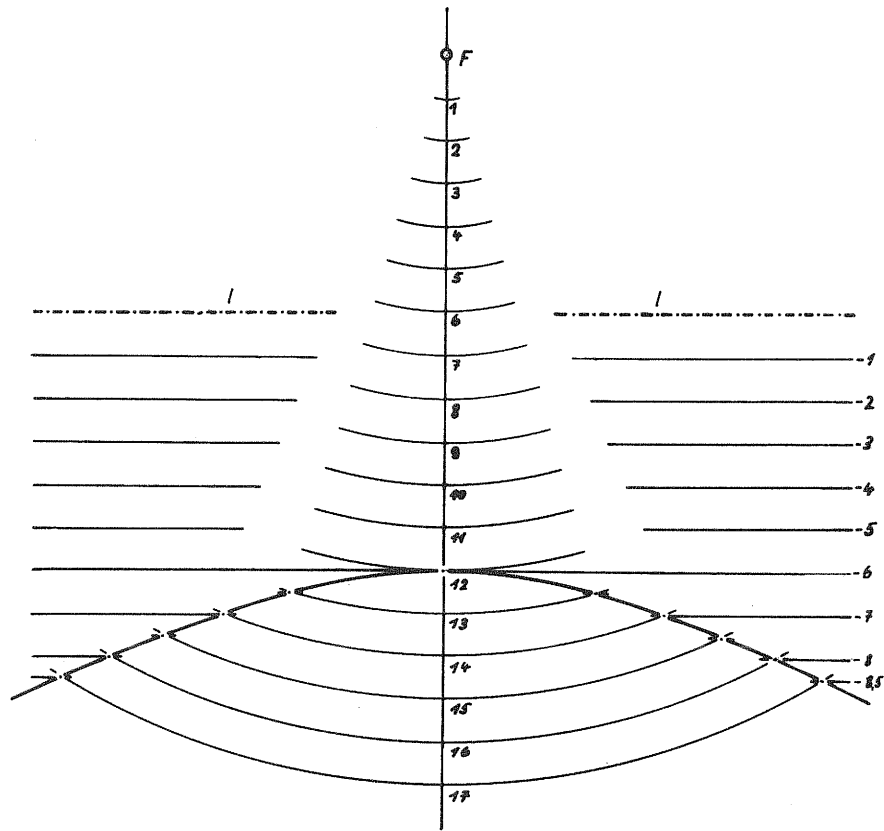

Figur 8

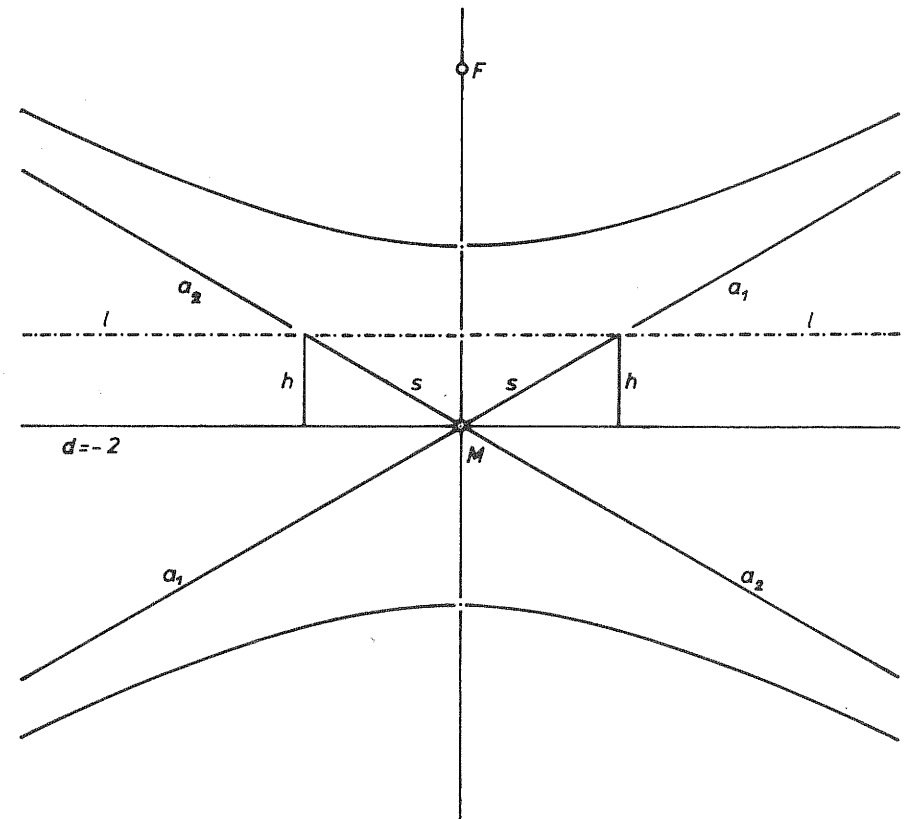

Figur 9



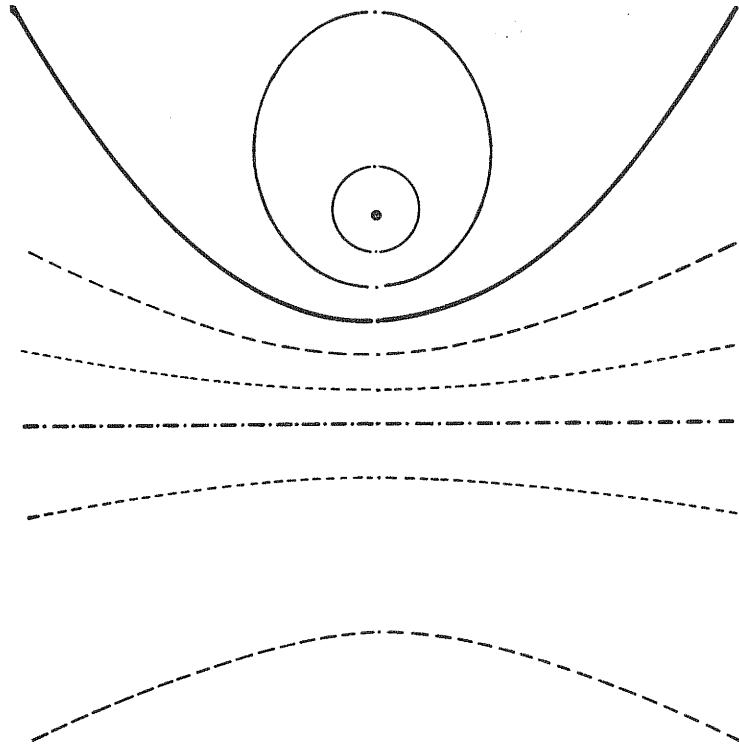

Figur 10

Geometrische Bilder für die  
 nachtodliche Verwandlung der  
 Kräftestruktur der Röhrenknochen  
 in diejenige der Kopfknochen

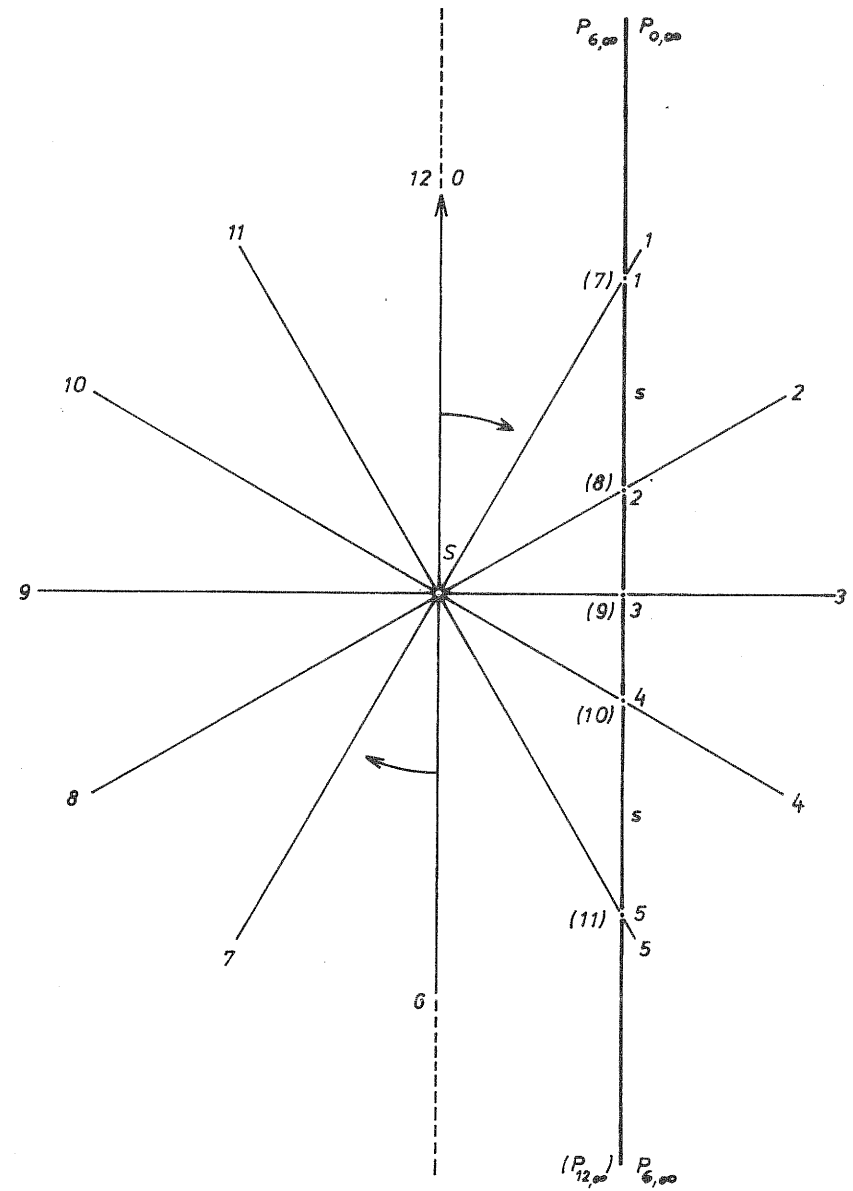

Figur 11

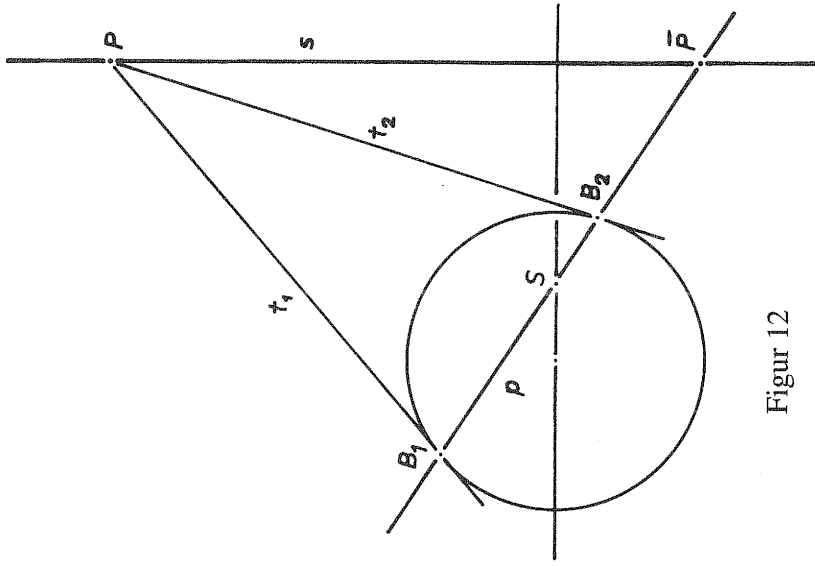

Figure 12

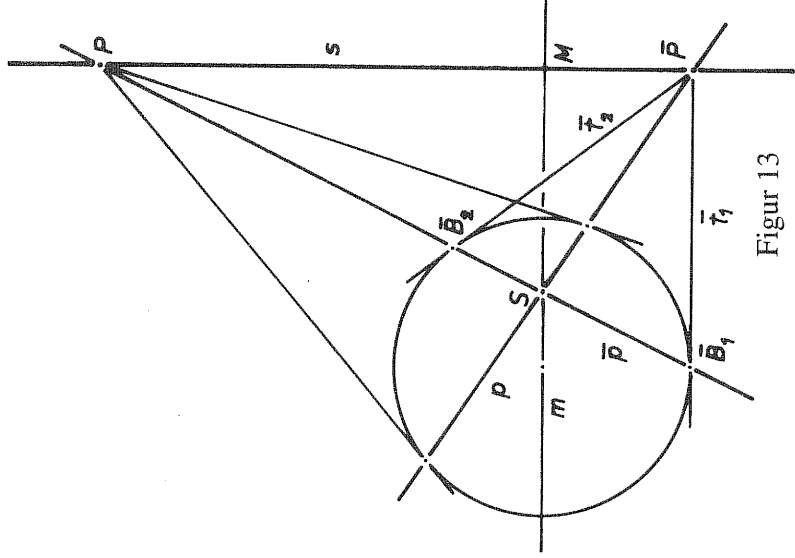

Figure 13

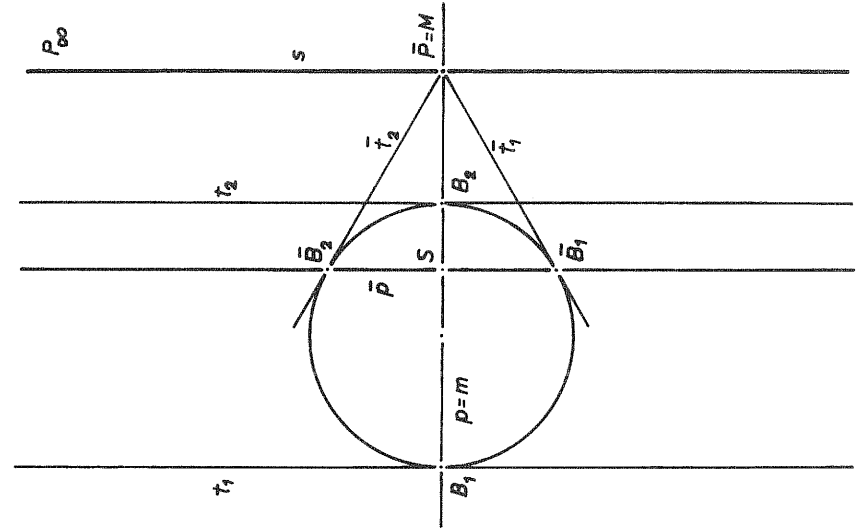

Figure 14

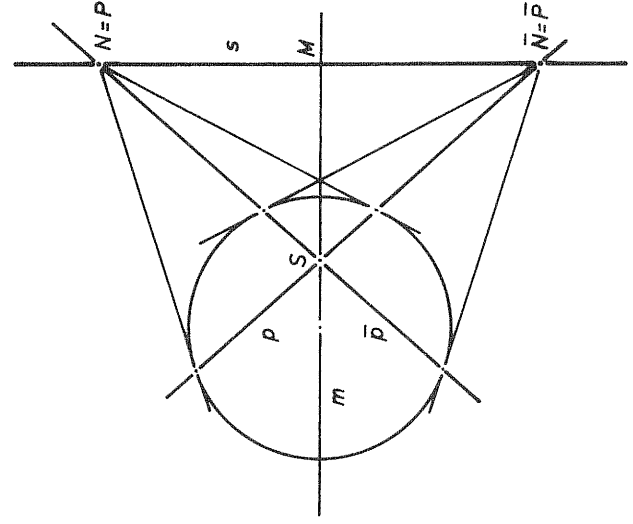

Figure 15

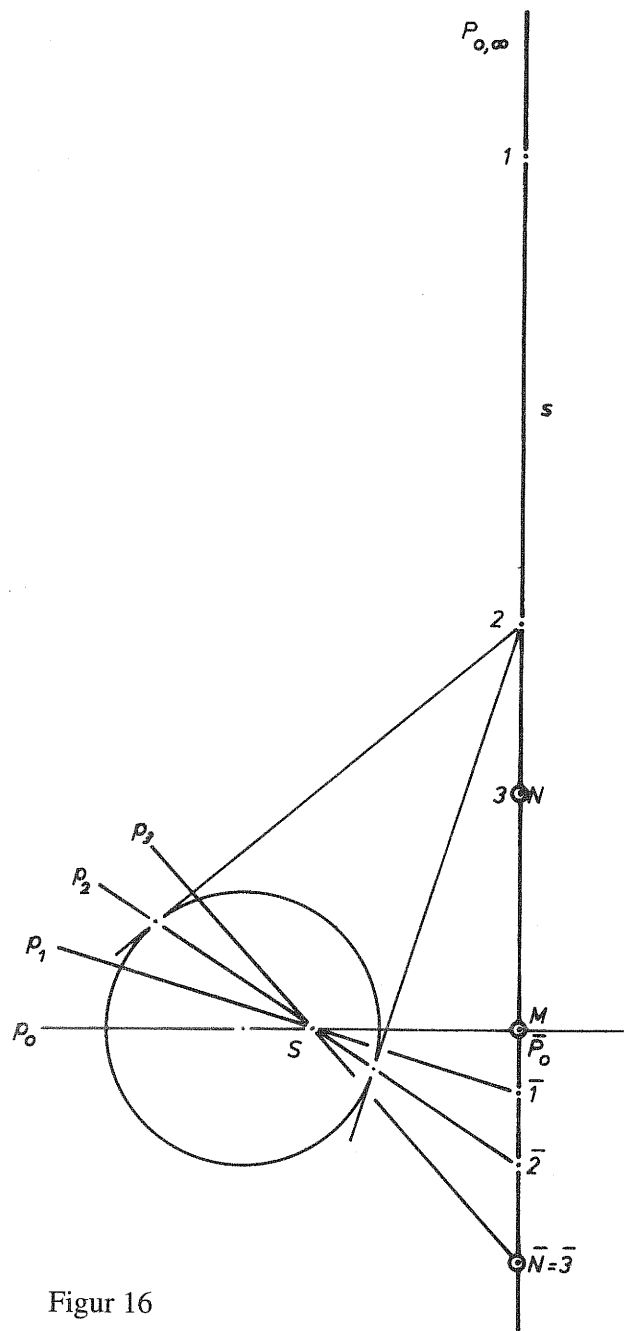

Figure 16

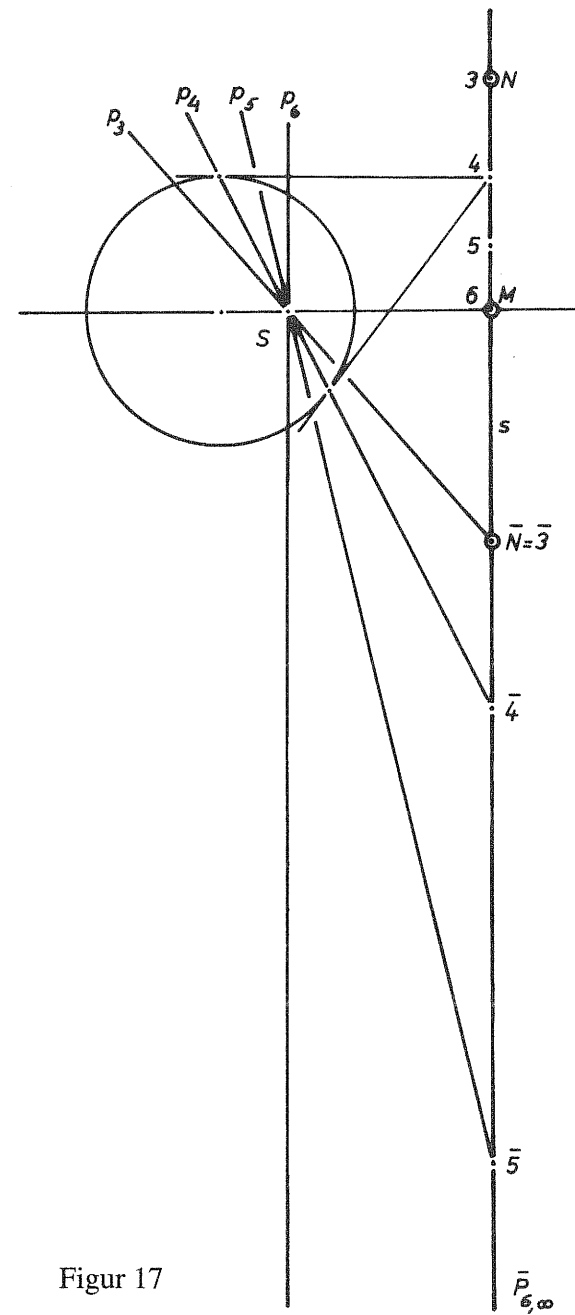
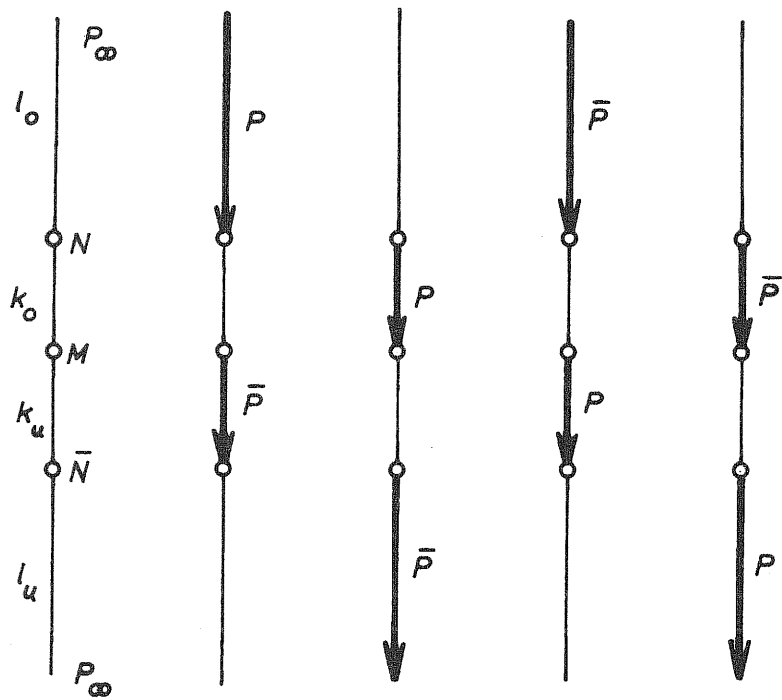
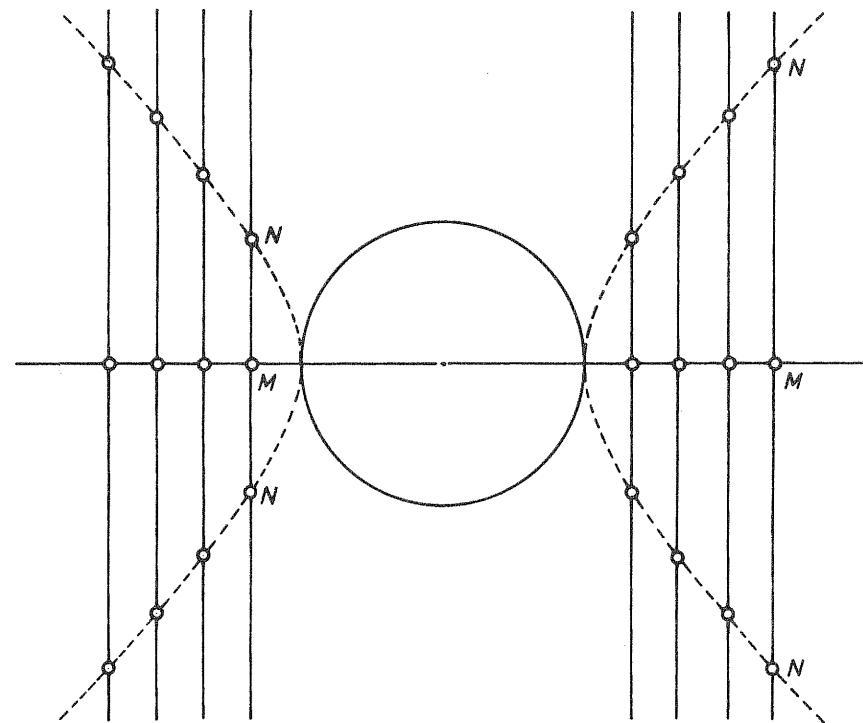

Figure 17



Figur 18



Figur 19

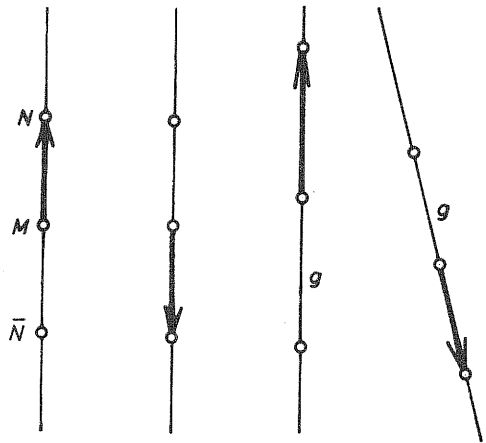

Figur 20

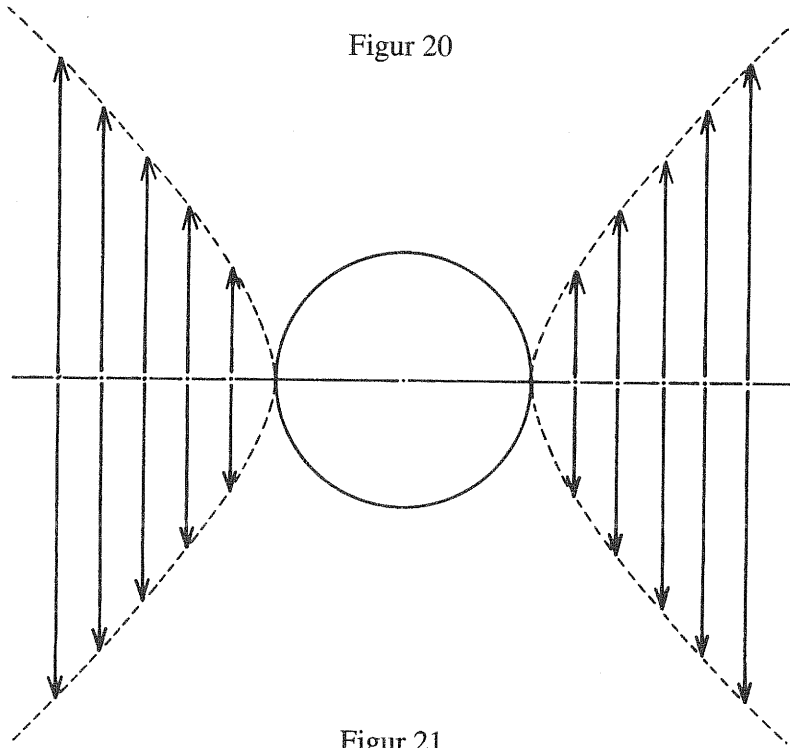

Figur 21

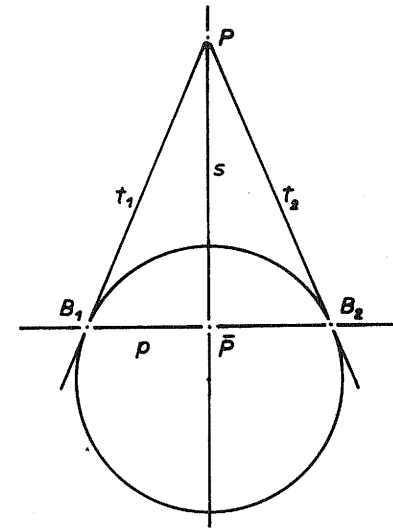

Figur 22

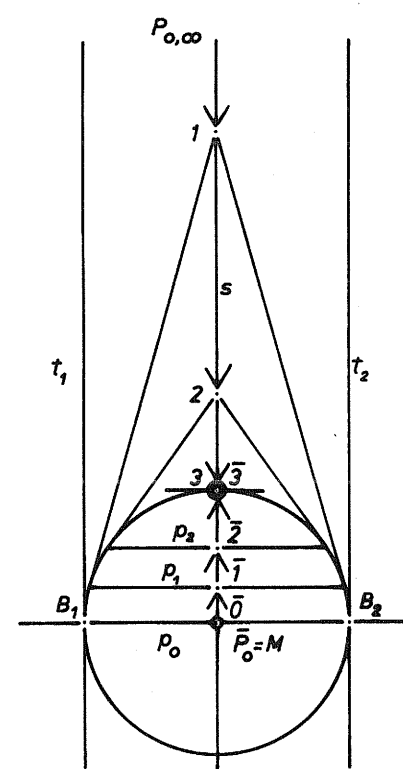

Figur 23

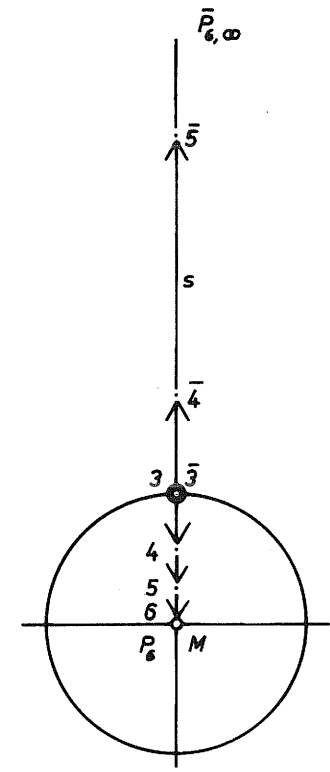

Figur 24

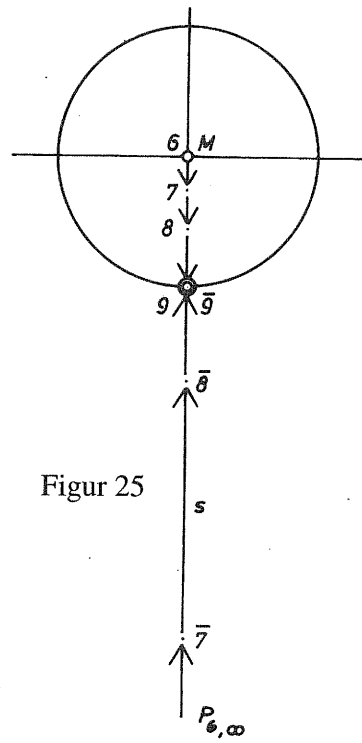

Figur 25

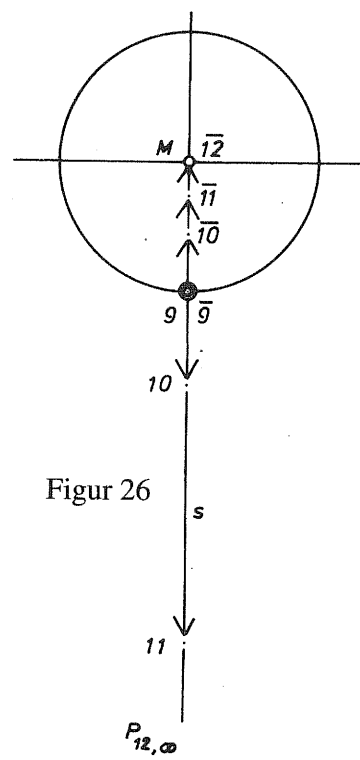

Figur 26

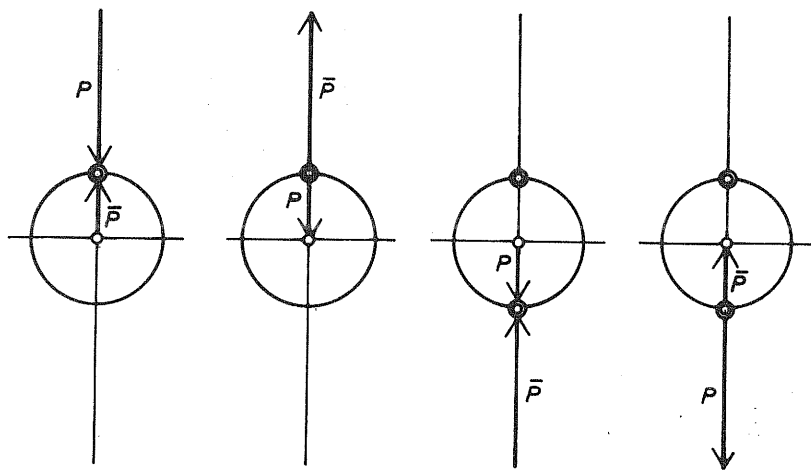

Figur 27

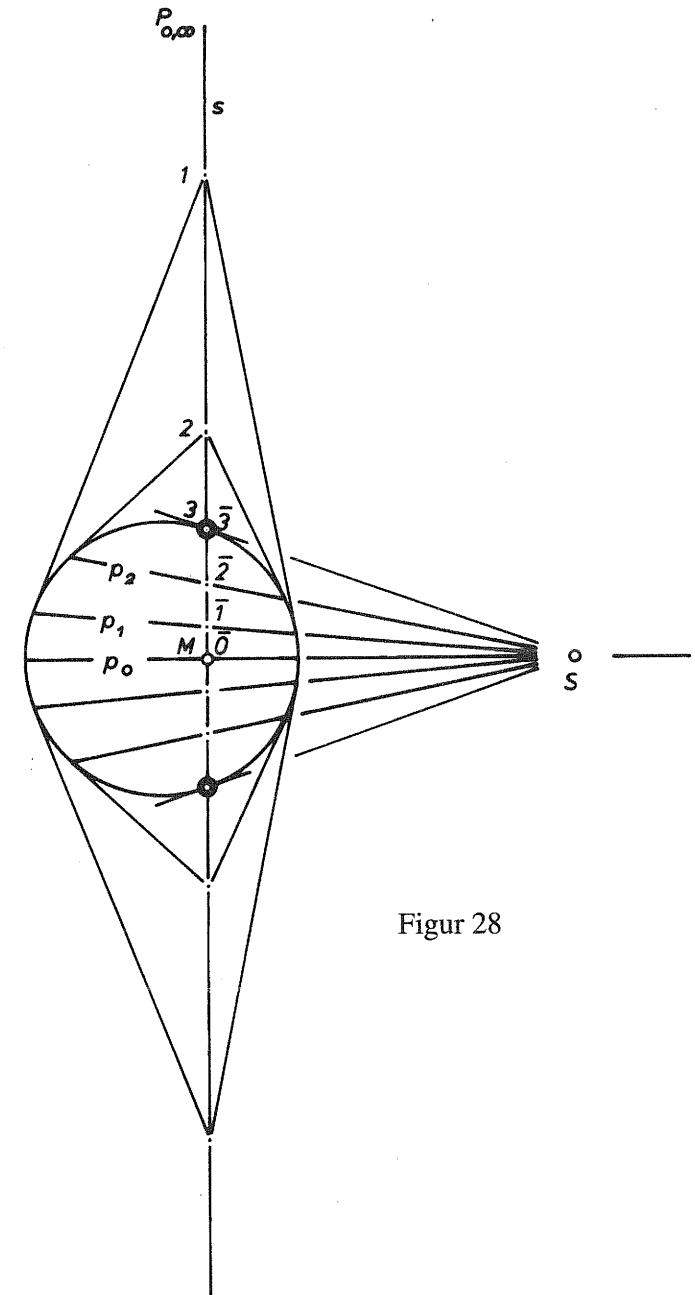

Figur 28

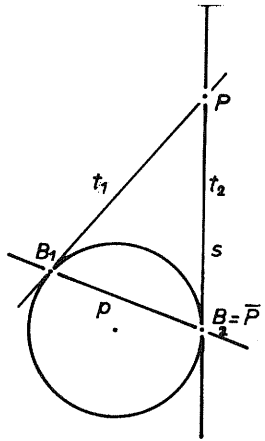

Figur 29

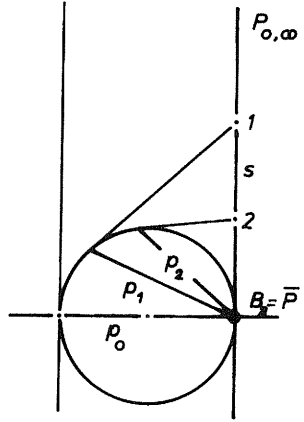

Figur 30

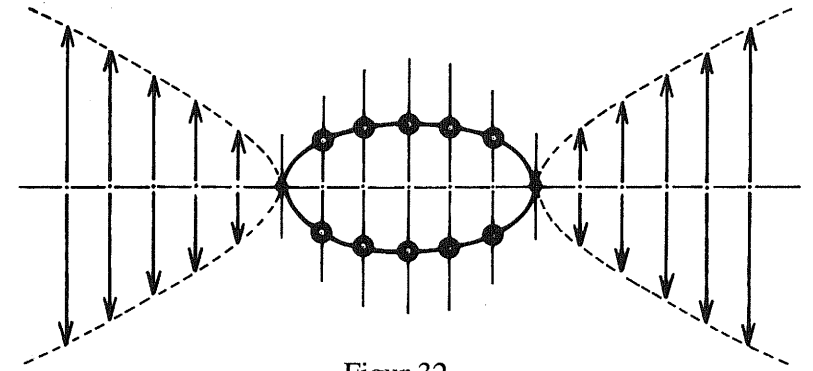

Figur 32

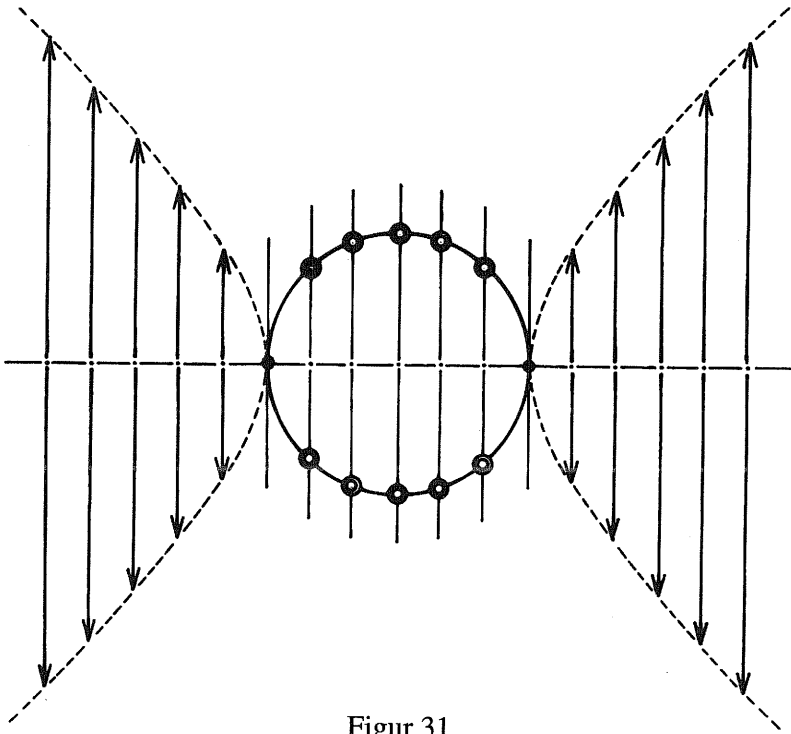

Figur 31

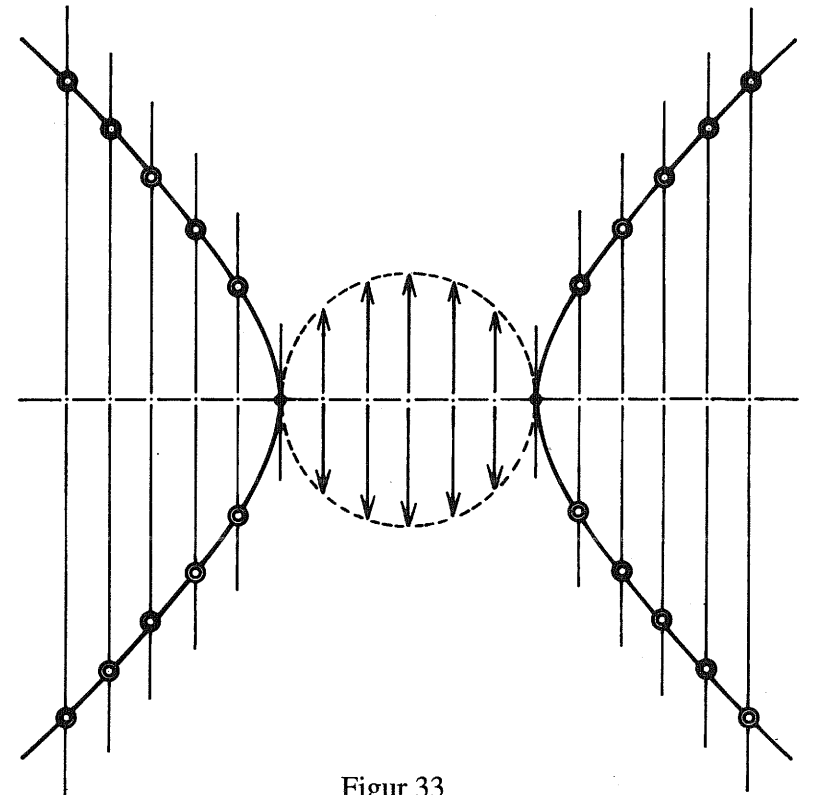

Figur 33



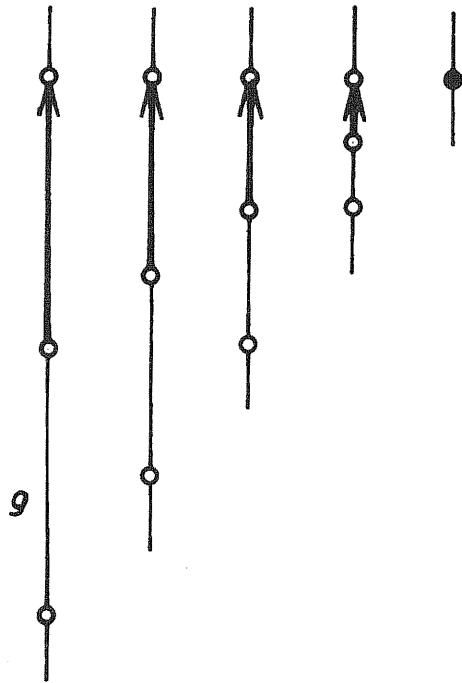

Figur 34



Figur 35

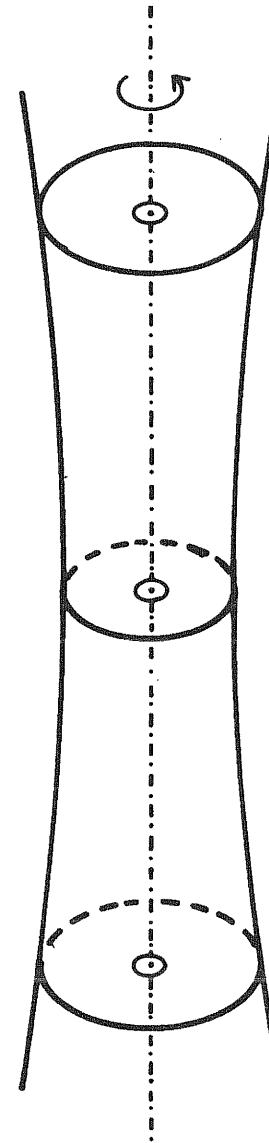

Figur 36

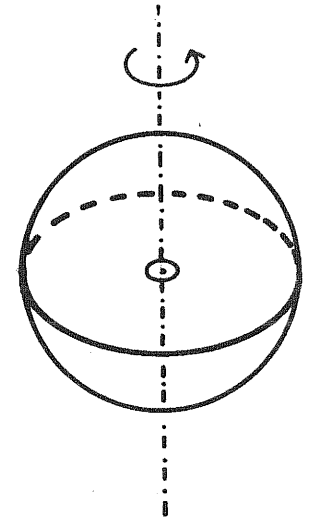

Figur 37

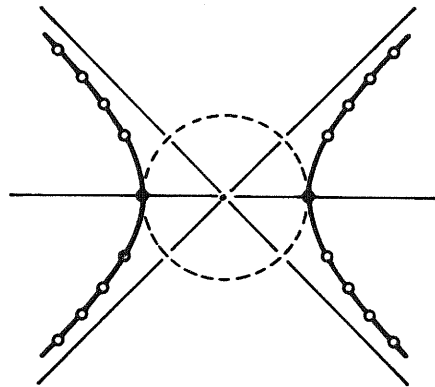

Figur 38a

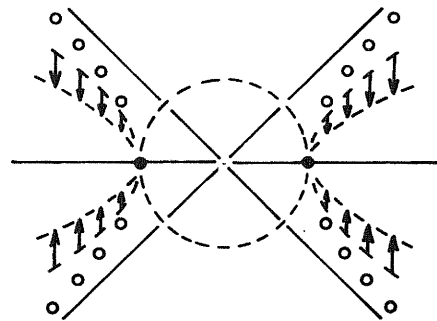

Figur 38b

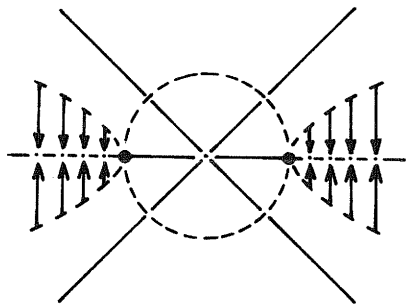

Figur 39

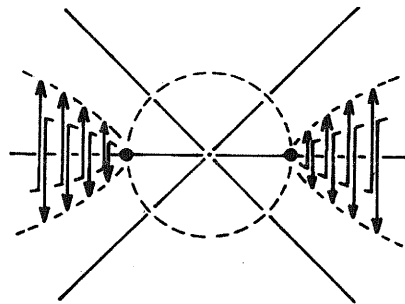

Figur 40

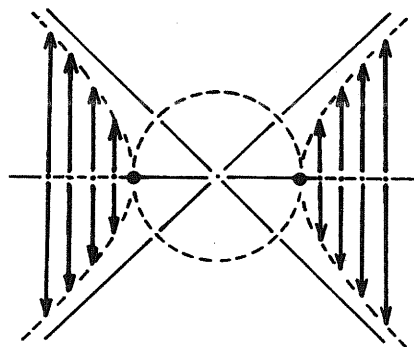

Figur 41

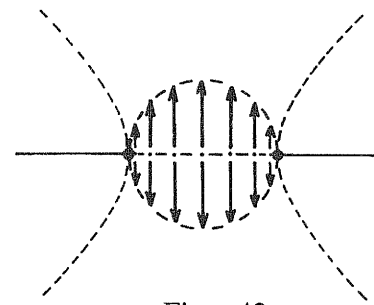

Figur 42a

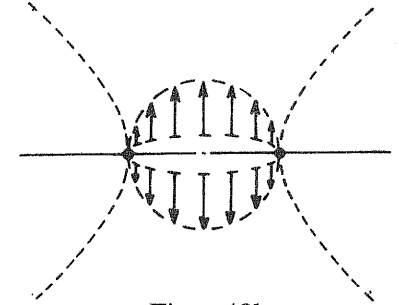

Figur 42b

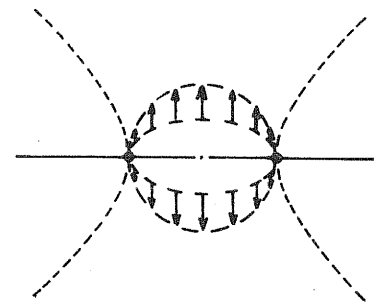

Figur 43

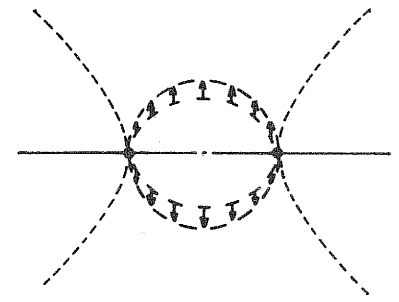

Figur 44

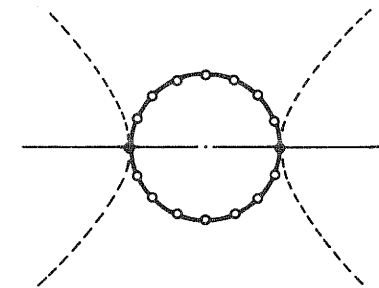

Figur 45